



Commercial Debris Blower/Vacuum Operator's Manual



Model 36
New for 2010

Patents Pending

September 19, 2009
Hurricane Inc.
Muskegon, Michigan

Identification

Record Identification Numbers

If you need to contact an Authorized Service Center for information on servicing, always provide the product model and serial numbers. You will need to locate the model and serial numbers for the machine and for the engine of your machine and record the information in the spaces provided.

Date of purchase: _____

Dealer name: _____

Dealer phone: _____

PRODUCT IDENTIFICATION NUMBER:

Model Number: _____

Serial Number: _____

ENGINE MODEL, SPECIFICATION, AND SERIAL NUMBER:

Model Number: _____

Specification: _____

Serial Number: _____

Register this information with Hurricane Inc. by email at register@hurricaneblovac.com, be sure to include your contact information as well as the above data for warranty and service bulletins.

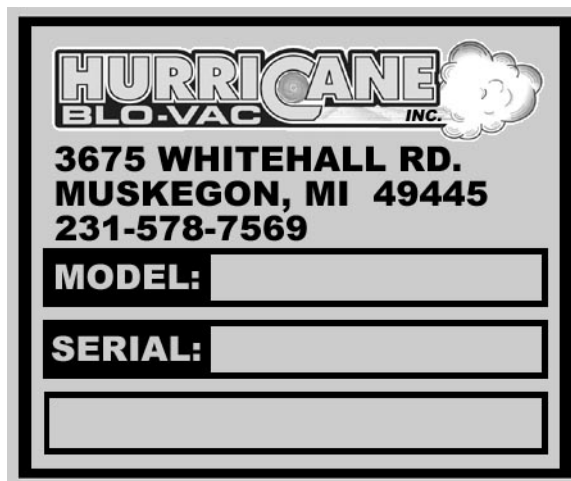

HURRICANE
BLO-VAC INC. 

3675 WHITEHALL RD.
MUSKEGON, MI 49445
231-578-7569

MODEL: _____

SERIAL: _____

Above information can be found on this data plate and the engine data plate.

Introduction

Using Your Operator's Manual

This manual is an important part of your machine and should remain with the machine when you sell it.

Use the safety and operating information in the machine operator's manual to operate and service the machine safely and correctly.

This owners manual explains the features and promotes the safe use of this machine. Please read it in its entirety and follow the instructions carefully so that you may have many years of safe and productive operation.

An engine manufacturer's owner's manual has been provided with your machine. This will provide maintenance and troubleshooting information for the engine installed in your machine.

Special Messages

Your manual contains special messages to bring attention to potential safety concerns, machine damage as well as helpful operating and servicing information. Please read all the information carefully to avoid injury and machine damage.



SAFETY ALERT

This is the safety alert symbol. It is used throughout this manual and on the blower's safety labels to alert you to potential personal injury hazards. Obey all safety messages that follow this symbol to avoid possible injury or death. Read these instructions carefully. It is essential that you read the instructions and safety precautions before you attempt to work on or use this machine.



WARNING

This symbol with the "WARNING" indicates a potentially hazardous situation which, if not avoided, could result in death or serious injury.



CAUTION

This symbol with the word "CAUTION" indicates a potentially hazardous situation which, if not avoided, may result in minor or moderate injury.

SAFETY

Operator Training Required

- Read the operator's manual and other training material. If the operator or mechanic cannot read English, it is the owner's responsibility to explain this material to them. This publication is available in other languages.
- Become familiar with the safe operation of the equipment, operator controls, and safety signs.
- All operators and mechanics should be trained. The owner of the machine is responsible for training the users.
- Never let children or untrained people operate or service the equipment. Local regulations may restrict the age of the operator.
- The owner/user can prevent and is responsible for accidents or injuries occurring to themselves, other people, or property.
- Train operators on the machine in an open, unobstructed area under the direction of an experienced operator.

Preparation

- Evaluate the terrain to determine what accessories and attachments are needed to properly and safely perform the job. Only use accessories and attachments approved by the manufacturer.
- Wear appropriate clothing including hard hat, safety glasses and hearing protection. Tie back long hair, remove loose clothing or jewelry that may get tangled in moving parts.
- Inspect the area where the equipment is to be used and remove all objects such as rocks, toys, etc. which can be thrown by the machine.
- Use extra care when handling gasoline and other fuels. They are flammable and vapors are explosive.
 - a. Use only an approved container.
 - b. Never remove gas cap or add fuel when engine is running. Do not smoke.
 - c. Never refuel or drain the machine indoors.
- Check that the operator's presence controls, safety switches and shields are attached and functioning properly. Do not operate unless they are functioning properly.

Operating Safely

- Never run an engine in an enclosed area where dangerous carbon monoxide fumes can collect.
- Only operate in good light, keeping away from holes and hidden hazards.

SAFETY

Operating Safely

- Be sure all drives are in neutral and parking brake is engaged before starting engine. Only start engine from the operator's position.
- Slow down and use extra care on hillsides. Be sure to travel in the recommended direction on hillsides. For this machine, drive across hillsides, not up and down. Turf conditions can affect the machine's stability. Use caution while operating near drop-offs.
- Slow down and use caution when making turns and when changing directions on slopes.
- Never operate with the shields, or other guards, not securely in place. Be sure all interlocks are attached, adjusted properly, and functioning properly.
- Do not change the engine governor setting or overspeed the engine. Operating the engine at excessive speed can increase the hazard of personal injury and machine damage.
- Stop on level ground, engage parking brake, close deflectors, and shut off engine before leaving the operator's position for any reason.
- Stop equipment and inspect impeller if an abnormal vibration occurs. Make necessary repairs before resuming operations.
- Keep hands and feet away from the Intake and discharge.
- Look behind and down before backing up to be sure of a clear path.
- Never carry passengers and keep pets and bystanders away.
- Slow down and use caution when making turns and crossing roads and sidewalks. Close deflectors if not blowing. Watch for traffic when operating near or crossing roadways.
- Be aware of the blower discharge direction and do not point it at anyone.
- Do not operate the machine while under the influence of alcohol or drugs.
- Use care when loading or unloading the machine into or off of a trailer or truck.
- Use care when approaching blind corners, shrubs, trees, or other objects that may obscure vision.
- Inspect machine before you operate. Be sure hardware is tight. Repair or replace damaged, badly worn, or missing parts. Be sure guards and shields are in good condition and fastened in place. Make any necessary adjustments before you operate.
- Before using, always visually inspect to see that the impeller, its bolt, and blower assembly are not worn or damaged. Replace worn or damaged impeller and bolt.
- Keep safety labels visible when installing accessories and attachments.
- Do not wear radio or music headphones. Safe service and operation require your full attention.
- When machine is left unattended, stored, or parked, remove the key.

SAFETY

Using a Spark Arrestor

The engine in this machine is not equipped with a spark arrestor muffler. It is a violation of California Public Resource Code Section 4442 to use or operate this engine on or near any forest-covered, brush-covered or grass-covered land unless the exhaust system is equipped with a spark arrestor meeting any applicable local or state laws. Other states or federal areas may have similar laws.

A spark arrestor for your machine is available from your authorized dealer. An installed spark arrestor must be maintained in good working order by the operator.

Checking Working Area

- Evaluate the terrain to determine what accessories and attachments are needed to properly and safely perform the job.
- Clear work area of objects that might be thrown. Keep people and pets out of working area.
- Study working area. Set up a safe blowing pattern. Do not blow where traction or stability is doubtful.
- Test drive through area with blower not running. Slow down when you travel over rough ground.

Parking Safely

1. Stop machine on a level surface, not on a slope.
2. Close deflectors.
3. Engage the parking brake.
4. Stop the engine.
5. Remove the key.
6. Wait for engine and all moving parts to stop before you leave the operator's station.
7. Close fuel shut-off valve, if your machine is equipped.
8. Disconnect the negative battery cable or remove the spark plug wires (for gasoline engines) before servicing the machine.

Rotating Impeller is Dangerous

- Rotating impeller can cut off arms and legs, and throw objects. Failure to observe safety instructions could result in serious injury or death.
- Keep hands, feet and clothing away from blower housing when engine is running.
- Be alert at all times, drive forward carefully. People, especially children can move quickly into the working area before you know it.

SAFETY

Protect Children

- Death or serious injury can occur when young children associate having fun with a lawn equipment simply because someone has given them a ride on a machine.
- Children are attracted to lawn equipment and activities. They don't understand the dangers or the fact that the operator is unaware of their presence.
- Children who have been given rides in the past may suddenly appear in the work area for another ride and be run over or backed over by the machine.
- Tragic accidents with children can occur if the operator is not alert to the presence of children, especially when a child approaches a machine from behind. Before and while backing up, look down and behind the machine carefully, especially for children.
- Never carry children on a machine or attachment. Do not tow children in a cart or trailer. They can fall off and be seriously injured or interfere with safe machine operation.
- Never use the machine as a recreational vehicle or to entertain children.
- Never allow children or an untrained person operate the machine. Instruct all operators not to give children a ride on the machine or in an attachment.
- Keep children indoors, out of the work area, and in the watchful eye of a responsible adult, other than the operator, when a machine is being operated.
- Stay alert to the presence of children. Never assume that children will remain where you last saw them. Turn the machine off if a child enters the work area.

Avoid Tipping

- Slopes are a major factor related to loss-of-control and tip-over accidents, which can result in severe injury or death. Operation on all slopes requires extra caution.
- Blow across slopes, not up and down.
- Watch for holes, ruts, bumps, rocks, or other hidden objects. Uneven terrain could overturn the machine. Tall grass can hide obstacles.
- Choose a low ground speed so you will not have to stop while on a slope.
- Do not blow or operate machine on wet grass. Tires may lose traction.
- Tires may lose traction on slopes even though the brakes are functioning properly.
- Avoid starting, stopping or turning on a slope. If the tires lose traction, turn and proceed slowly, straight down the slope.
- Keep all movement on slopes slow and gradual. Do not make sudden changes in speed or direction, which could cause the machine to roll over.

SAFETY

Avoid Tipping

- Use extra care while operating machine with attachments, they can affect stability of the machine. Do not use on steep slopes.
- Do not blow near drop-offs, ditches, embankments, or bodies of water. The machine could suddenly roll over if a wheel goes over the edge or the edge caves in.
- Follow the manufacturer's recommendations for wheel weights or counterweights for added stability when operating on slopes or using front or rear mounted attachments. Remove weights when not required.
- Drive machine very slowly and avoid quick stops.

Keep Riders Off

- Only allow the operator on the machine. Keep riders off.
- Riders on the machine or attachment may be struck by foreign objects or thrown off the machine causing serious injury.
- Riders obstruct the operator's view resulting in the machine being operated in an unsafe manner.

Avoid High Pressure Fluids

- Hydraulic hoses and lines can fail due to physical damage, kinks, age, and exposure. Check hoses and lines regularly. Replace damaged hoses and lines.
- Hydraulic fluid connections can loosen due to physical damage and vibration. Check connections regularly. Tighten loose connections.
- Escaping fluid under pressure can penetrate the skin causing serious injury. Avoid the hazard by relieving pressure before disconnecting hydraulic or other lines. Tighten all connections before applying pressure.
- Search for leaks with a piece of cardboard. Protect hands and body from high pressure fluids.
- If an accident occurs, **see a doctor immediately**. Any fluid injected into the skin must be surgically removed within a few hours or gangrene may result. Doctors unfamiliar with this type of injury should reference a knowledgeable medical source.

Checking Wheel Hardware

- An accident could occur causing serious injury if wheel hardware is not tight.
- Check wheel hardware tightness often during the first 100 hours of operation.
- Wheel hardware must be tightened to specified torque using the proper procedure anytime it is loosened.

SAFETY

Wear Appropriate Clothing

- Always wear safety goggles, or safety glasses with side shields, and a hard hat when operating the machine.
- Wear close fitting clothing and safety equipment appropriate for the job.
- While blowing, always wear substantial footwear and long trousers. Do not operate the equipment when barefoot or wearing open sandals.
- Wear a suitable hearing protection device such as earplugs. Loud noise can cause impairment or loss of hearing.

Maintenance and Storage

- Never operate machine in a closed area where dangerous carbon monoxide fumes can collect.
- Disengage drives, engage parking brake, stop engine and remove key or disconnect spark plug (for gas engines). Wait for all movement to stop before adjusting, cleaning or repairing.
- Clean all debris from unit, drives, mufflers, and engine to help prevent fires. Clean up oil or fuel spillage.
- Let engine cool before storing and do not store near flame.
- Shut off fuel while storing or transporting. Do not store fuel near flames or drain indoors.
- Park machine on level ground. Never allow untrained personnel to service machine. Understand service procedure before doing work.
- Use jack stands or lock service latches to support components when required. Securely support any machine elements that must be raised for service work.
- Before servicing machine or attachment, carefully release pressure from any components with stored energy, such as hydraulic components or springs.
- Release hydraulic pressure by moving hydraulic control levers back and forth with the engine off.
- Disconnect battery or remove spark plugs (for gas engines) before making any repairs. Disconnect the negative terminal first and the positive last. Reconnect positive first and negative last.
- Use care when checking impeller. Wear gloves, and use caution when servicing them. Only REPLACE impeller. **Never attempt to straighten or weld them.**
- Keep hands, feet, clothing, jewelry and long hair away from moving parts. If possible, do not make adjustments with the engine running.
- Charge battery in an open well ventilated area, away from spark and flames. Unplug charger before connecting or disconnecting from battery. Wear protective clothing and use insulated tools.

SAFETY

Maintenance and Storage

- Keep all parts in good working condition and all hardware tightened. Replace all worn or damaged decals.
- Keep all nuts and bolts tight, especially impeller attachment bolts, to be sure the equipment is in safe working condition.
- Check brake operation frequently. Adjust and service as required.

Prevent Fires

- Remove debris from engine compartment and muffler area, before and after operating machine, especially after blowing in dry conditions.
- Always shut off fuel when transporting or storing machine, the machine has a fuel shutoff.
- Do not store machine near an open flame or source of ignition, such as a water heater or furnace.
- Check fuel lines, tank, cap, and fittings frequently for cracks or leaks. Replace if necessary.

Tire Safety

Explosive separation of a tire and rim parts can cause serious injury or death:

- Do not attempt to mount a tire without the proper equipment and experience to perform the job.
- Always maintain the correct tire pressure. Do not inflate the tires above the recommended pressure. Never weld or heat a wheel and tire assembly. The heat can cause an increase in air pressure resulting in a tire explosion. Welding can structurally weaken or deform the wheel.
- When inflating tires, use a clip-on chuck and extension hose long enough to allow you to stand to one side and NOT in front of or over the tire assembly.
- Check tires for low pressure, cuts, bubbles, damaged rims or missing studs and nuts.

Handling Fuel Safely

To avoid personal injury or property damage, use extreme care in handling fuel. Fuel is extremely flammable and fuel vapors are explosive:

- Extinguish all cigarettes, cigars, pipes, and other sources of ignition.
- Use only an approved fuel container. Use only non-metal, portable fuel containers approved by the Underwriter's Laboratory (U.L.) or the American Society for Testing & Materials (ASTM). If using a funnel, make sure it is plastic and has no screen or filter.

SAFETY

Handling Fuel Safely

- Never remove the fuel tank cap or add fuel with the engine running. Allow engine to cool before refueling.
- Never add fuel to or drain fuel from the machine indoors. Move machine outdoors and provide adequate ventilation.
- Clean up spilled fuel immediately. If fuel is spilled on clothing, change clothing immediately. If fuel is spilled near machine, do not attempt to start the engine but move the machine away from the area of spillage. Avoid creating any source of ignition until fuel vapors have dissipated.
- Never store the machine or fuel container where there is an open flame, spark, or pilot light such as on a water heater or other appliance.
- Prevent fire and explosion caused by static electric discharge. Static electric discharge can ignite fuel vapors in an ungrounded fuel container.
- Never fill containers inside a vehicle or on a truck or trailer bed with a plastic liner. Always place containers on the ground away from your vehicle before fueling.
- Remove fuel-powered equipment from the truck or trailer and refuel it on the ground. If this is not possible, then refuel such equipment with a portable container, rather than from a fuel dispenser nozzle.
- Keep the nozzle in contact with the rim of the fuel tank or container opening at all times until the fueling is complete. Do not use a nozzle lock open device.
- Never overfill fuel tank. Replace fuel tank cap and tighten securely.
- Replace all fuel container caps securely after use.
- For gasoline engines, do not use gas with methanol. Methanol is harmful to your health and to the environment.

Handling Waste Product and Chemicals

- Waste products, such as, used oil, fuel, coolant, brake fluid, and batteries, can harm the environment and people:
- Do not use beverage containers for waste fluids - someone may drink from them.
- See your local Recycling Center or authorized dealer to learn how to recycle or get rid of waste products.
- A Material Safety Data Sheet (MSDS) provides specific details on chemical products: physical and health hazards, safety procedures, and emergency response techniques. The seller of the chemical products used with your machine is responsible for providing the MSDS for that product.

OPERATING

Operator Station Controls

- Let take a moment to familiarize you with the controls on the dash. A clear understanding of the operation and function of each control is essential to the safe and productive use of this machine.

Parking Brake



- This photo shows the parking brake **engaged** with all other controls in the off/neutral position. The parking brake should be in this position starting, parking, vacuuming, or anytime other than when the machine is in motion with an operator present at the controls.



- This photo shows the parking brake **disengaged**.

OPERATING

Operator Station Controls

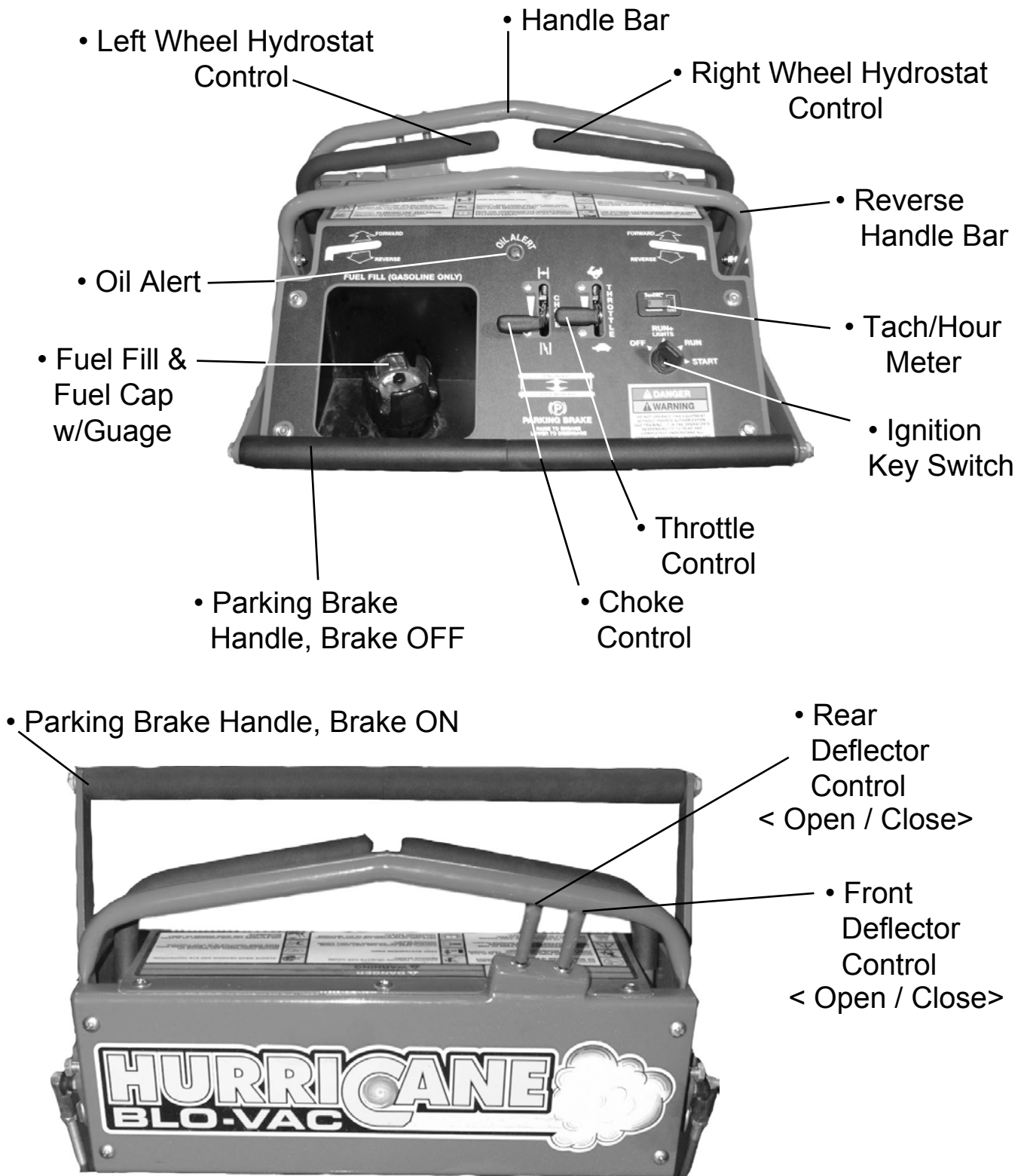

OPERATING

Misc. Controls and Checks



Hydraulic Oil expansion tank and filler
(Fill to bottom line when cold.)

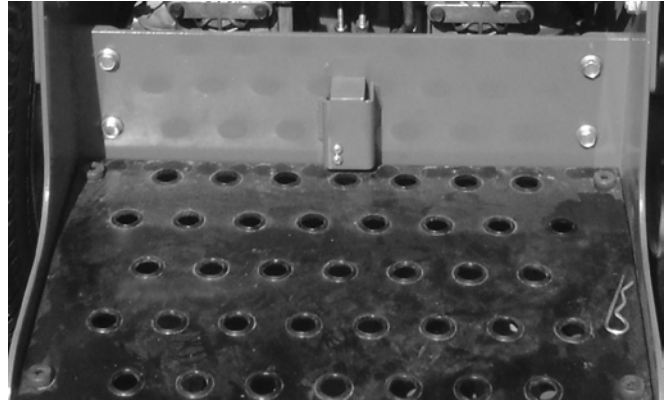

Step onto the operator platform, disengage parking brake, grasp the handle bar to operate the machine. Engage parking brake before stepping off the machine.

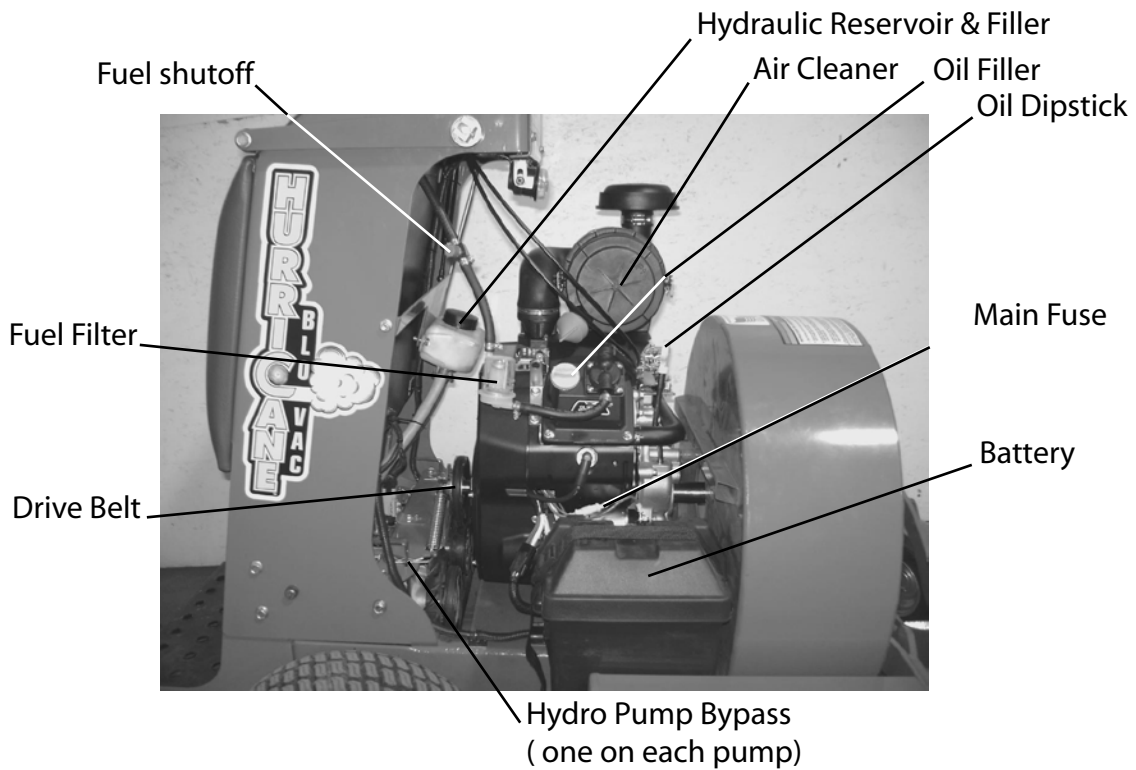

OPERATING

Misc. Controls and checks

Underside view of machine

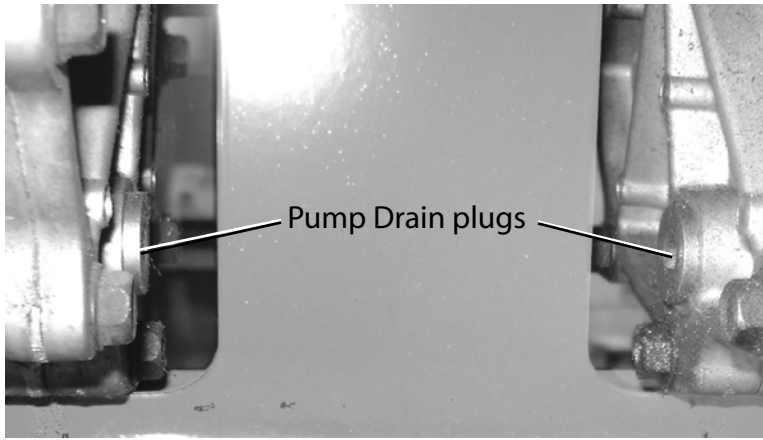

- Hydraulic Pumps
Change hydraulic oil every 400 hours.



- Hydraulic Oil Filters
One on each pump.
Change every 400 hours

- Remove Filter Guard bolts to access filter for service.

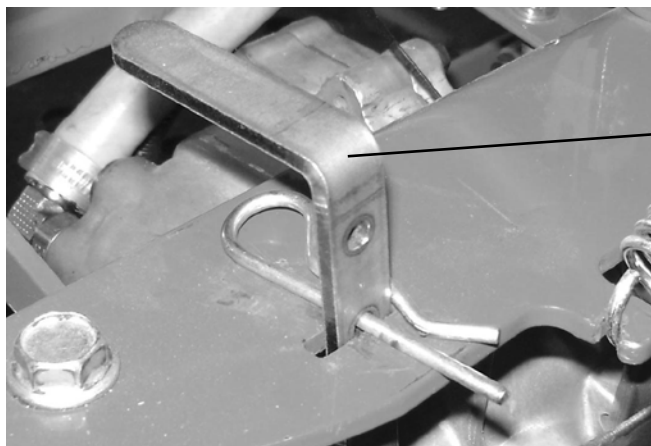

- Hydraulic Pump bypass Valves
To bypass, lift lever, remove R-key from storage location and install in lower hole as shown.

OPERATING

Testing the safety systems

The safety systems installed on your machine should be tested before each machine use. Be sure you have read this manual and are completely familiar with the operation of the machine before performing these safety system checks.

If there is a malfunction during one of these procedures, do not operate machine. See your authorized dealer for service.
Perform these tests in a clear open area outdoors. Keep bystanders away.

Use the following checkout procedures to check for normal operation of the machines safety systems.

Testing Saftety cover Switch (Start)

1. Engage parking brake.
2. Remove Blower saftey cover.
2. Stand on operator's platform with motion control levers in the neutral position.
4. Turn key switch to the start position.

Result: The engine must not crank.

Testing Park Brake Switch (Start)

1. Disengage parking brake.
2. Turn key switch to the start position.

Result: The engine must not crank.

Testing Neutral Switch (Start)

1. Engage parking brake.
2. Push one motion control lever forward.
3. Turn key switch to the start position. Repeat steps 2, 3 for other control.

Result: The engine must not crank.

Testing Saftety cover Switch (Run kill)

1. Engage parking brake.
2. Start engine. Idle engine.
3. Open blower saftey cover.

Result: The engine must stop.

Testing Operator Presence Switch (Run kill)

1. Stand on operator's platform with motion control levers in the neutral position.
2. Engage parking brake. Start engine. Idle engine.
3. Disengage park brake.
4. Step completely off operator's platform.

Result: The engine must stop.

OPERATING

Testing the safety systems

Testing Operator Presence Neutral Switches (Run kill)

1. Engage parking brake.
 2. Stand on operator's platform with motion control levers in the neutral position.
 3. Start engine. Idle engine.
 4. Disengage parking brake.
 5. Move motion control levers slightly forward, slower than walking speed.
 6. Step completely off operator's platform.
 7. Release the motion control levers, allowing them to return to the neutral position.
- Result: The engine must stop.

Testing the Parking Brake

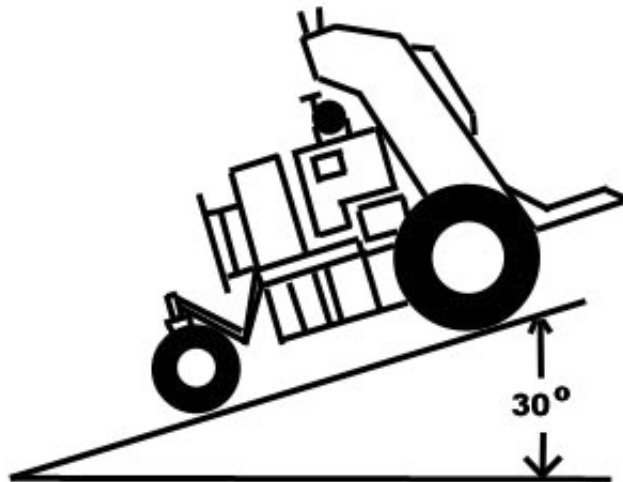

1. Stop machine on a 17° slope (30% grade) facing downhill. Stop the engine and engage parking brake.
2. Repeat procedure with machine facing uphill.

Result: Parking brake must hold the machine stationary.
(Machine should move no more than 24 in (61cm) in one hour.)
If machine moves more than that, brakes need to be adjusted.
See your authorized dealer or refer to Adjusting Parking Brake in the SERVICE section.

OPERATING

Using the Throttle and Choke

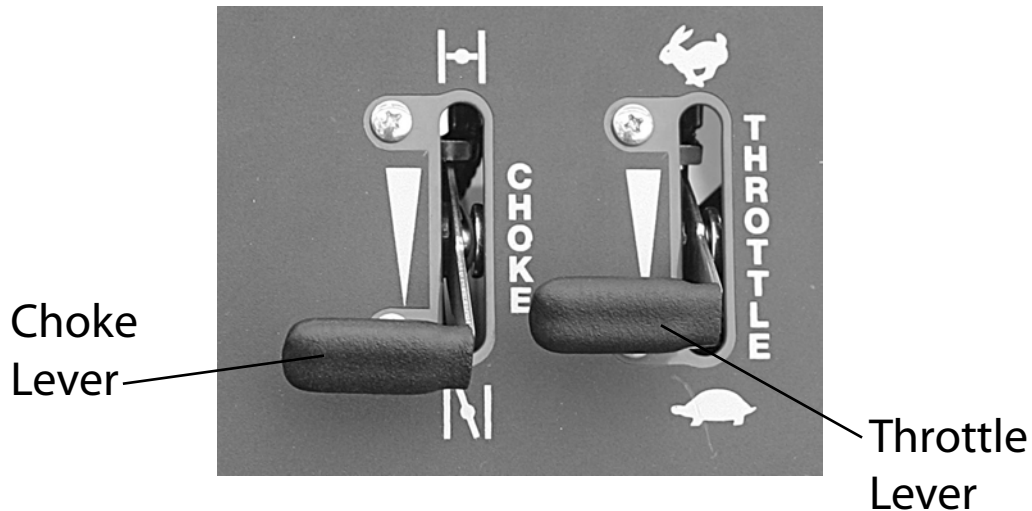

Starting Using the Throttle and Choke

- Push choke lever forward to the closed position.
- Move throttle lever to the half fast position when starting and warming the engine.
- Turn key switch to the start position and release when engine starts, pulling choke control back to the open position after engine start.
- Blower speed and power can be controlled with the throttle control.

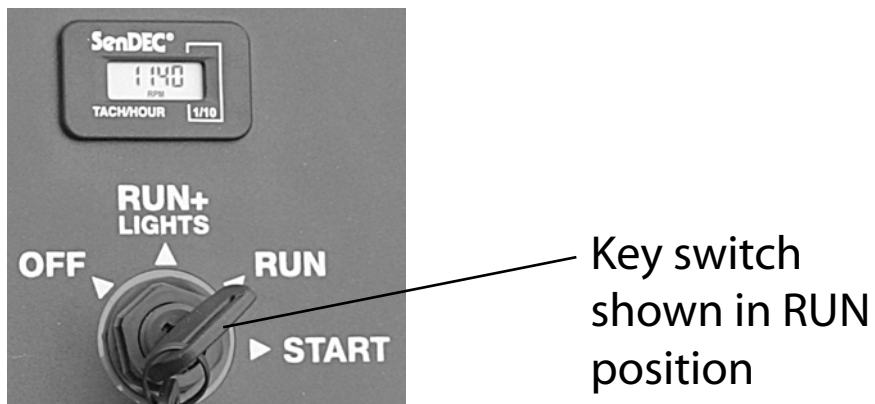

- The Tach/hour meter shows the engine revolutions per minute when the engine is running and the engine hours when engine is off. The meter will also show reminders when to change the engine oil. The meter only runs when the engine is running and is independent of the key switch.

OPERATING

Filling Fuel Tank



CAUTION: Avoid injury! Fuel vapors are explosive and flammable:

- Shut engine off before filling fuel tank.
- Do not smoke while handling fuel.
- Keep fuel away from flames or sparks.
- Fill fuel tank outdoors or in well ventilated area.
- Clean up spilled fuel immediately.
- Use clean approved non-metal container to prevent static electric discharge.
- Use clean approved plastic funnel without screen or filter to prevent static electric discharge.

IMPORTANT: Avoid damage! Dirt and water in fuel can cause engine damage:

- Clean dirt and debris from the fuel tank opening.
- Use clean, fresh, stabilized fuel.
- Fill the fuel tank at the end of each day's operation to keep condensation out of the fuel tank.
- Use a non-metallic funnel with a plastic mesh strainer when filling the fuel tank or container.

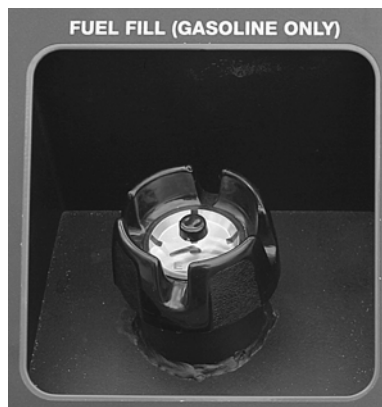

1. Park machine safely.
2. Allow engine to cool.
3. Remove any debris from around fuel tank cap/gauge area.
4. Remove fuel tank cap/gauge slowly to allow any pressure built up in tank to escape. Use caution with the gauge assembly to prevent damage to gauge.
5. Only fill fuel tank to bottom of filler neck.
Do not overfill.
Clean up spilled fuel immediately.
6. Reinstall fuel tank cap/gauge.

OPERATING

Using the Hydrostatic motion controls



CAUTION: Avoid injury! Learn the proper use of the motion control levers and practice at low throttle until becoming proficient and comfortable with the operation of the machine.

Do not move motion control levers from forward to reverse or reverse to forward position rapidly. Sudden direction changes could cause loss of control or damage the machine.

The functions of the hydrostatic motion control levers are:

- Forward and reverse movement.
- Steering.
- Acceleration and Deceleration.
- Stopping.



This photo shows the hydrostatic control levers are in the neutral position.

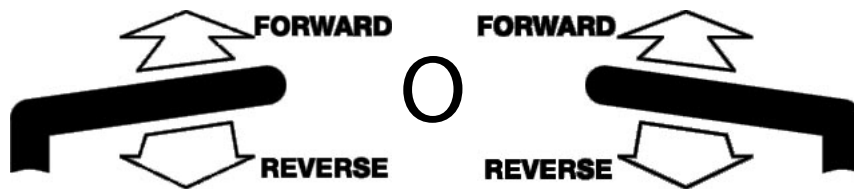

This is the neutral position.

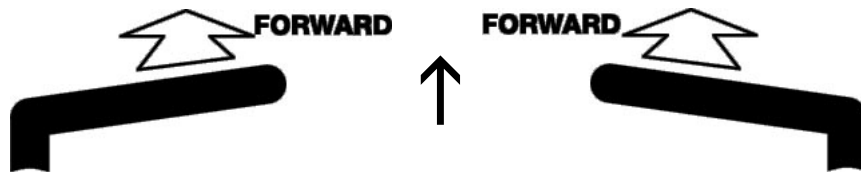

This is the forward travel position. The travel speed is dependant on how far forward the controls are pushed.

OPERATING

Using the Hydrostatic motion controls

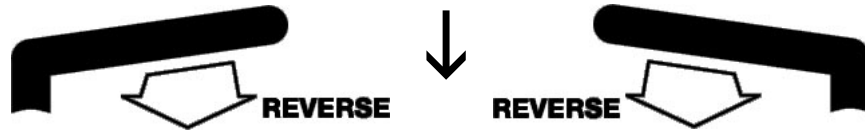

This is the reverse travel position. The travel speed is dependant on how far rearward the controls are pulled.

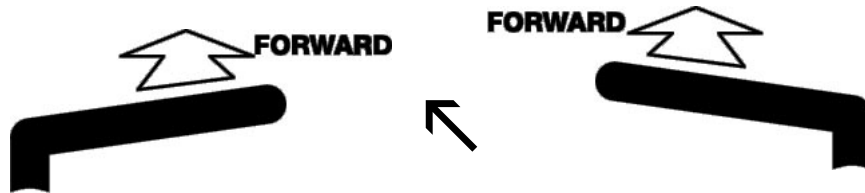

For a gentle left turn, Push the right motion control lever further forward than the left motion control lever.

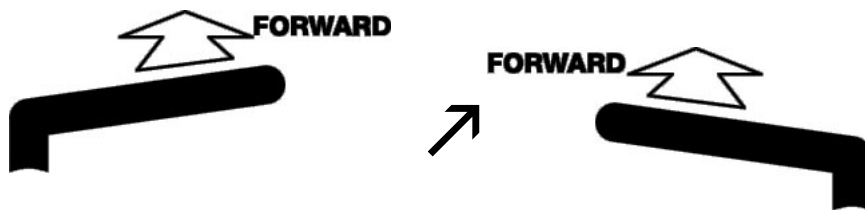

For a gentle right turn, Push the left motion control lever further forward than the right motion control lever.

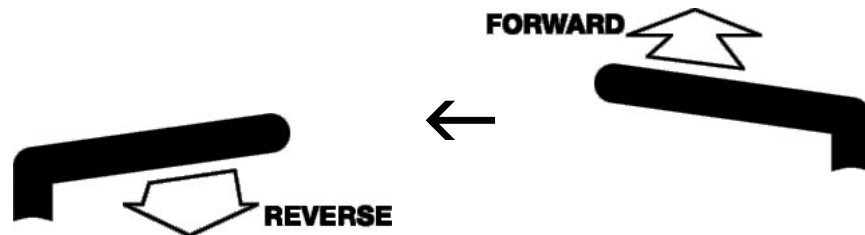

For a sharp left turn, Pull the left motion control lever rearward and push the right motion control lever forward.

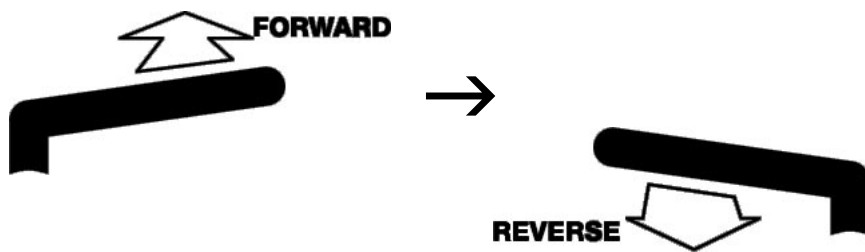

For a sharp right turn, Push the left motion control lever forward and pull the right motion control lever rearward.

OPERATING

Using the Blower and the Deflector controls



CAUTION: Avoid injury and property damage!

DO NOT position discharge where it will blow debris towards people, vehicles, buildings or other objects in vicinity. Flying debris may damage, harm, or cause injury to people or objects in air flow range.

Keep a safe distance between two or more operators and machines when working together in the same areas.



KEEP HANDS AND FEET AWAY FROM AIR INTAKE AND AIR DISCHARGE. PINCH POINTS AND CRUSHING FORCES WILL CAUSE SEVERE INJURY.

DANGER ROTATING FAN - DON'T ATTEMPT TO REMOVE MATERIALS FROM INTAKE OR DISCHARGE WHEN BLOWER IS RUNNING. ENGAGE PARKING BRAKE, STOP ENGINE, REMOVE KEY AND WAIT UNTIL ALL MACHINERY HAS COME TO A COMPLETE STOP.

The functions of the Deflector control switches are:

- Starting and Stopping the air stream.
- Adjusting the air pattern.



OPERATING

Using the Blower and the Deflector controls

These photos show the Deflectors in both the closed and open positions.



Closed

<Front



Open

Note: The deflectors can be set in any position between open and closed.

Tip: The photo with the deflectors open is a ideal setting for blowing heavy leaves and debris.

With a little time and experience, an operator can become proficient in setting the deflectors at the optimum positions for the task.

Hint: From the operators position, the user can see the deflector gear racks and judge the position of the deflectors.

With the deflectors at about half open, like the front deflector in the above photo, the air stream is directed downward under the debris and is useful for blowing wet leaves, grass and dirt.

Remember: Air velocity can be controlled by the throttle control as well as by the deflectors.

Remember: Air stream (deflectors) should be closed off when nessasary, IE., when traveling from one area to another, past flower and bark beds, Etc.

SERVICE

Service Intervals

Use the following schedule to perform routine maintenance on your machine.

Break-In (After First 10 Hours)

- Change engine oil and filter.
- Check hydraulic fluid level.
- Check and adjust park brake.
- Check wheel lug nut torque.
- Check air pressure in tires.
- Check hydraulic pump drive belt.

Every 40 Hours

- Check hydraulic fluid level.
- Check and adjust park brake.
- Check wheel lug nut torque.
- Check air pressure in tires.
- Check hydraulic pump drive belt.
- Check air cleaner elements.
- Clean engine shrouds as needed.
- Clean behind engine shrouds and exposed fins.
- Clean behind engine cooling fan screen.

First 75 Hours

- Change hydraulic oil and filters.

Every 100 Hours

- Change engine oil and filter.
- Check hydraulic pump drive belt.
- Clean and gap spark plugs.
- Clean behind engine shrouds and exposed fins.
- Clean behind engine cooling fan screen.

Every 400 Hours

- Change hydraulic oil and filters.

Annually

- Change fuel filter.
- Clean battery.
- Change engine oil and filter at least once per season.
- Change hydraulic oil and filters at least once per season.
- Replace spark plugs.

Front Caster Spindles and Wheels are sealed bearings and are lubricated for life. There are no greaseable points on this machine.

SERVICE

Service Engine

Servicing Engine

See engine manufacturer's owner's manual provided with your machine for engine service information.

Engine Oil

Use oil viscosity based on the expected air temperature range during the period between oil changes. See engine manufacturer's manual for the oil specifications.

Checking Engine Oil Level

IMPORTANT: Avoid Engine Damage! Failure to check the oil level daily could lead to serious engine problems if oil level is low. Check oil level before operating.

Keep oil level between the FULL and the ADD marks. Check oil level when engine is stopped, level, and is cooled so oil has had time to drain into the sump.

NOTE: Check oil frequently if you run engine all day. Make sure engine is cool when checking engine oil level. Check oil between jobs during periods of heavy use.

NOTE: Engine has an OIL ALERT that will stop the engine if there is a loss of oil pressure and/or will not allow engine to start if it has no oil.



SERVICE

Service Engine

Checking Engine Oil Level

1. Park machine safely.
2. Check when engine is cool before use or allow engine to cool.
3. Clean area around dipstick to prevent debris from falling into crankcase.
4. Remove dipstick. Wipe with a clean cloth.
5. Install dipstick fully.
6. Remove dipstick and check oil level on dipstick. Oil must be between the ADD and FULL marks.
 - If oil is low, add oil to bring oil level no higher than the FULL mark on dipstick.
 - If oil level is above the FULL mark, drain to proper level.

Changing Engine Oil and Filter

IMPORTANT: Avoid Damage! Change the oil more often if the machine is used in extreme conditions:

Extremely dusty conditions.

Frequent slow or low-speed operation.

Frequent short trips.

1. Park machine safely.
2. Clean area around dipstick, filler cap and filter.
3. Make sure engine is cool.
4. Put oil drain pan underneath engine.

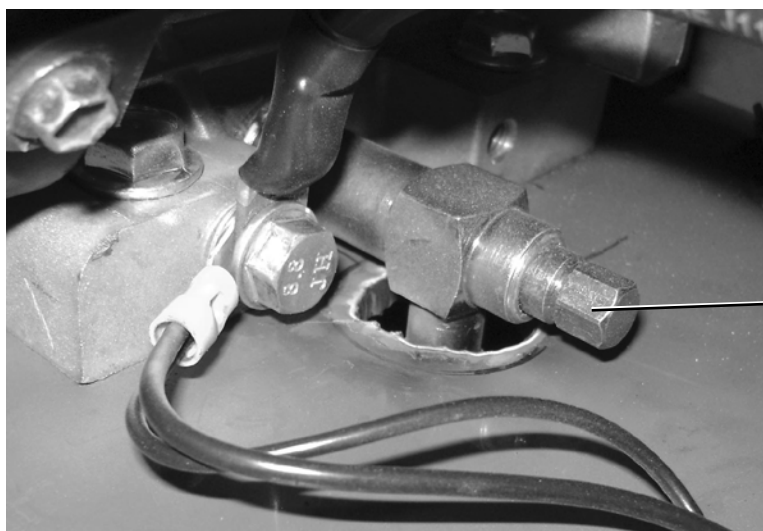

SERVICE

Service Engine

Changing Engine Oil and Filter

5. Open oil drain valve fully.
6. Allow oil to drain into an oil drain pan.
7. After oil drains, securely tighten oil drain valve.

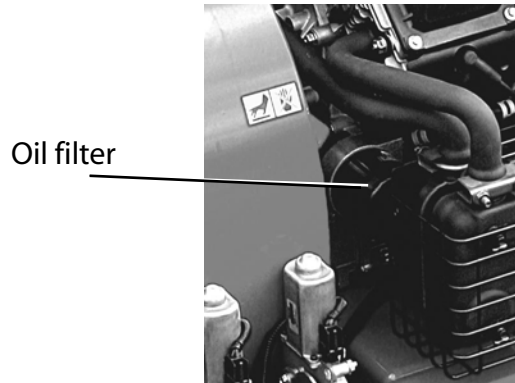

IMPORTANT: Make sure engine and exhaust system is cool before proceeding. The oil filter is located behind the muffler which can cause severe burns if the engine is hot.

8. Place some rags under the oil filter to contain spilled oil.
 9. Turn oil filter counterclockwise to remove. Pull the oil filter to the top of the muffler, tilt slightly to remove past the muffler.
 10. Apply a film of clean engine oil to gasket of new filter.
 11. Install filter. Turn filter clockwise until gasket makes contact with mounting surface. Tighten 1/2 to 3/4 turn after gasket contact.
- IMPORTANT:** Do not use wrench to tighten oil filter.

IMPORTANT: Refer to engine manufacturers operating manual for correct type and grade of oil.

12. Add approximately 1.75 quarts of oil.
13. Insert dipstick. Replace oil filler cap.
14. Start engine and run at slow throttle for approximately two minutes.
Check for leaks around oil filter and drain valve.
15. Stop engine.
16. Check oil level:
 - Remove dipstick. Wipe dipstick clean.
 - Insert dipstick fully and remove.
 - Add oil as needed to bring level to the full mark without overfilling.
17. Insert dipstick.

SERVICE

Service Engine

Cleaning Engine Oil Cooler and Checking Air Filter

Cleaning the engine oil cooler

Keep engine oil cooler fins clear of debris to ensure proper cooling. See the engine manufacturer's owner's manual provided with your machine for the complete procedure.

Checking Air Filter Elements

IMPORTANT: Avoid damage! Dirt and debris can enter the engine through a damaged filter element:

- Do not wash paper element.
- Do not attempt to clean paper element by tapping against another object.
- Do not use pressurized air to clean element.
- Do not clean elements, only replace element if it is very dirty, damaged or the seal is cracked.

Your machine is equipped with a Heavy-Duty Air Cleaner assembly.

Check air filter elements at the intervals recommended in the Service Intervals section.

NOTE: It may be necessary to check the air filter more frequently if operating machine in dusty or extreme conditions.

See the engine manufacturer's owner's manual provided with your machine for the complete procedure.

SERVICE

Service Engine

Replacing Fuel Filter



CAUTION: Avoid injury! Fuel vapors are explosive and flammable:

- Shut off engine before servicing.
- Cool engine before servicing.
- Work in a well-ventilated area.
- Do not smoke while handling fuel.
- Keep fuel away from flames or sparks.
- Clean up spilled fuel immediately.



1. Park machine safely.
2. Allow engine to cool.
3. Turn OFF fuel shut off valve.
4. Loosen and slide hose clamps away from fuel filter.
5. Place drain pan under hoses to catch any fuel that may be left in the hoses.
6. Disconnect hoses from fuel filter.
7. Install new fuel filter by connecting hoses to new fuel filter. Make sure fuel filter is installed in the proper direction.
8. Install hose clamps.
9. Turn ON fuel shut off valve.
10. Start engine and check for fuel leaks.

SERVICE

Service Engine

Checking Engine Cooling Intake and Fan

IMPORTANT: Avoid damage! An obstructed air intake screen can cause engine damage due to overheating.



CAUTION: Avoid injury! Compressed air can cause debris to fly a long distance.

Clear work area of bystanders.

Wear eye protection when using compressed air for cleaning purposes.

Reduce compressed air pressure to 210 kPa (30 psi).

Keep air intake screen and other external surfaces of the engine, including cooling fins, clean at all times to allow adequate cooling.

Clean air intake screens and engine cooling fins of debris with compressed air to ensure proper cooling. See the engine manufacturer's owner's manual provided with your machine for the complete procedure.

Checking Spark Plugs



CAUTION: Avoid injury! Touching hot surfaces can burn skin. The engine, components, and fluids will be hot if the engine has been running. Allow the engine to cool before servicing or working near the engine and components.

Check spark plugs at the intervals recommended in the Service Intervals section. See the engine manufacturer's owner's manual provided with your machine for the complete procedure.

Checking Carburetor Adjustment

The carburetor is designed to deliver the correct fuel-to-air mixture to the engine under all operating conditions. To comply with current emissions regulations, the fuel mixture settings are made at the factory and are not adjustable.

NOTE: To ensure proper engine operation at altitudes above 5000ft (1525M), it may be necessary to have an authorized engine service center install a special high-altitude jet kit in the carburetor.

See the engine manufacturer's owner's manual provided with your machine for more information.

SERVICE

Service Hydraulics

Hydraulic Oil

Use only Mobil-1 synthetic 15W-50 oil or equivalent.

Checking Hydraulic Oil Level

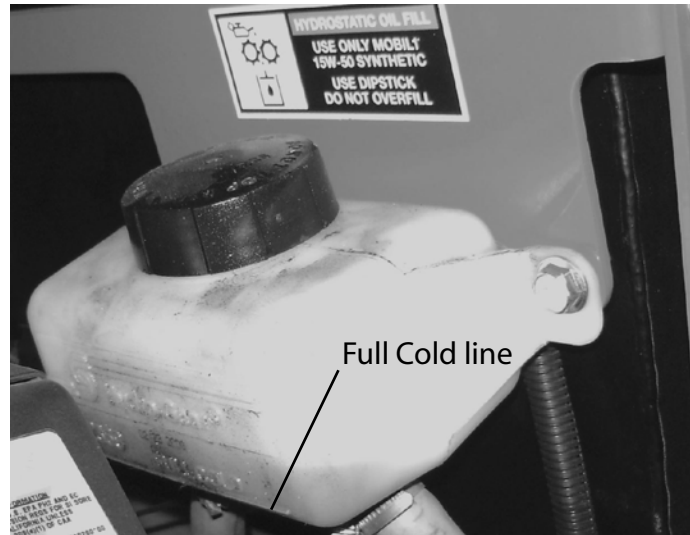

Hydraulic Oil tank and fill



CAUTION: Avoid injury! Escaping fluid under pressure can penetrate the skin causing serious injury. Avoid the hazard by relieving pressure before disconnecting hydraulic or other lines. Tighten all connections before applying pressure. Search for leaks with a piece of cardboard. Protect hands and body from high pressure fluids.

IMPORTANT: Check oil level in reservoir tank when oil is cold. Do not overfill oil reservoir tank. Oil will expand during operation and could overflow.

1. Park machine safely.
2. Allow engine to cool.
3. Clean reservoir and cap.
4. Sight through reservoir and insure oil level is at the full cold line. If oil is low, add oil to bring oil level no higher than FULL COLD mark on tank.
NOTE: If oil is above FULL COLD line, drain oil to proper level.
5. Tighten cap.

SERVICE

Service Hydraulics

Changing Hydraulic Oil and Filters, ZT-3100

The transaxles are designed with an external filter for ease of maintenance. To ensure constant fluid quality levels and longer life, an initial oil and filter change at 75 hours, then every 400 hours thereafter.

The following procedure can be performed with the transaxles installed in the machine, and the machine on level ground. Engage the parking brake and apply the bypass valve for each transaxle.

1. Park machine safely. Engage the parking brake.
2. Allow engine and transaxles to cool.
3. Jack machine up from rear. Use blocking to support machine.
4. Remove both rear tires. Apply the bypass valves for both transaxles.
5. Place drain pan under machine. The pan should hold more than 1.5 gallons or 6 quarts.



Transaxle drain plug.



Hydraulic oil filter.

6. Remove the two filter guard screws and filter guard. Clean any loose debris from around the perimeter of the filter. Place drain pan beneath the oil filter.
7. Remove the oil filter from the transaxle. Dispose of used filter properly.
8. After the oil has drained, wipe the filter base surface off and apply a film of new oil to the gasket of the new replacement filter.
9. Install the new filter by hand, turn 3/4 to one full turn after the filter gasket contacts the filter base surface. Do not use a wrench.
10. Re-install the filter guard with two screws. Torque screws to 65 in. lbs.
11. Repeat steps 6-10 on the opposite side transaxle drive.
12. Remove the top purge port plug from the left and right side transaxles.
13. Remove the drain plugs from both transaxles and allow to drain, when empty, replace plugs and torque to 180 in. lbs.
14. Remove the cap from the expansion tank, fill with 15W50 motor oil until oil just appears at the bottom of each transaxle's purge port (approximately 2 qts. per transaxle, 4 qts. total). Install the purge port plug into each transaxle as the oil level reaches this port.

SERVICE

Service Hydraulics

Changing Hydraulic Oil and Filters, ZT-3100

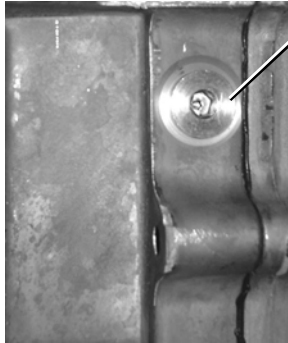

Purge port plug located on the top of the pumps

15. Torque the purge port plugs to 180 in. lbs.
16. Continue to fill the transaxles through the expansion tank until the "Full Cold" line is reached.
17. Re-install the expansion tank cap by hand. Be careful to not overtighten.
18. Continue with the following purge procedure.

PURGING PROCEDURE

NOTE: Due to the effects air has on hydrostatic drive systems, it is critical that air is purged from the systems.

The resulting symptoms of air in the hydrostatic systems may be:

1. Noisy operation.
2. Lack of power or drive after short term operation.
3. High operation temperature and excessive expansion of oil.

*(If starting here, Follow numbers 1-4 of the proceeding page before continuing).

19. Start engine and idle up to 1800 rpm. Disengage parking brake.
20. Slowly move the directional controls in both forward and reverse directions (5 or 6 times).
21. Release bypass valves.
22. Again, slowly move the directional controls in both forward and reverse directions (5 to 6 times).
23. Stop engine. Engage parking brake. Check the oil level, and add oil as required.
24. It may be necessary to repeat Steps 19 thru 23 until all the air is completely purged from the system.
25. Re-install rear tires and lower machine.
26. Operate machine under normal conditions, when the transaxle operates at normal noise levels and moves smoothly forward and reverse at normal speeds, then the transaxle is considered purged. If necessary, repeat the purge procedure.

SERVICE

Service Hydraulics

Changing Hydraulic Pump Drive Belt

Use this procedure to change out a worn or damaged drive belt.

1. Park machine safely. Remove key.
2. Allow machine to cool.
3. Remove belt guard.
4. Using a 3/4" boxed end wrench on the idler pulley bolt, pull against tensioner pulley spring to gain slack in belt.
5. Pull belt from left side and slip belt off from the left pump pulley and then the right pump pulley.
6. Release wrench on tensioner and remove belt from idler and engine pulleys.
7. Install new belt in reverse order and re-install the belt guard.

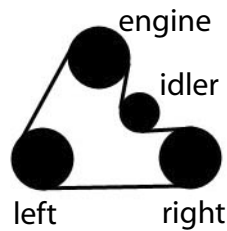
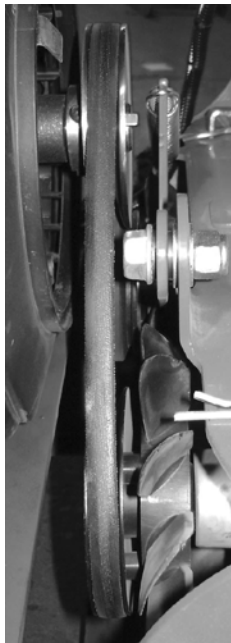

Drive belt routing diagram

Belt shown with belt guard removed



SERVICE

Service Impeller

Changing Impeller

1. Park machine safely. Remove key.
2. Allow machine to cool.
3. Take off the front safety cover by removing the keeper pin and rotating cover counterclockwise and pulling cover straight out of opening.

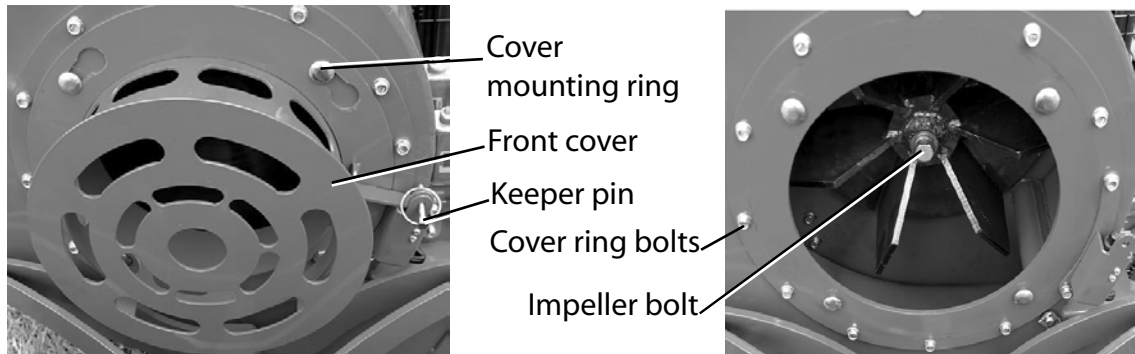

4. Remove the cover mounting ring by loosening and removing the twelve bolts holding the ring to the blower housing. Use caution with the safety switch and wiring.
5. Remove the impeller retaining bolt. Use a 2"x4" or something similar to hold the impeller and engine from turning.
6. Using a 3/4"-10 x 6" all-thread tap bolt, screw bolt into the nut welded on the impeller to remove impeller from the engine crankshaft. Continue to tighten bolt until impeller slides off engine shaft. Remove bolt from impeller.

Caution should be used when removing impeller, its heavy and there is not enough room for your fingers in the opening with the impeller, hold onto the impeller by the fins using gloves to remove it from the housing.

7. Remove old impeller.
8. Reinstall the new impeller on the engine shaft aligning the keyway.
9. Reinstall the impeller retaining bolt and washers with blue thread locker.
Tighten to 120 ft lbs.
10. Reinstall the cover mounting ring and safety cover switch.
11. Reinstall the safety cover and keeper pin.

SERVICE

Service Brakes

Adjusting the Parking Brake

It should not be necessary to adjust the transaxle parking brakes over the life of the machine. In the event that the transaxle parking brake does not hold per specifications, the parking brake can be adjusted.

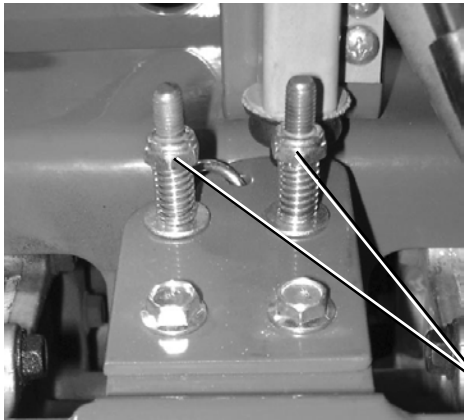

Brake engage
adjustment nut

Brake adjustment
rods

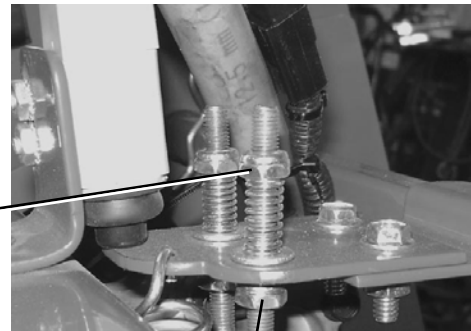

Brake release adjusting nut

1. Park machine safely on a level surface.
2. Disengage parking brake.
3. Push down hard on the brake adjustment rods, if either rod moves down, adjust by turning the brake release nut counterclockwise until rod is tight.
4. Engage parking brake and rock machine until both brake adjustment rods pop up, then pull up on both rods, if rods move up, increase spring tension by turning brake engage nut clockwise until rod is held up by spring. Do not over-tighten.

SERVICE

Service Motion Controls

Adjusting the Motion Controls

1. Park machine safely. Stop engine.
2. Chock wheels. Release parking brake.
3. Move both motion controls toward the handle bar full forward.
4. There should be exactly 1/16" between the motion controls and the handle bar. If the distance is greater or the controls touch the handle bar, adjustment is needed.



Motion control adjustment
(Left side shown)

5. There are adjusters located by the transaxles on the control linkages. Loosen the jam nuts on the top and bottom of the adjuster.
Note: The top nuts are left hand thread and the bottom are right hand thread.
6. Holding the control forward to the handle bar, rotate the adjuster to get the 1/16" clearance to the handle bar and tighten the jam nuts. Repeat for both sides.
7. Engage parking brake.

Adjusting Motion Controls - Checking Neutral Center

1. Choose a hard, level surface to perform this test.
2. Mount the machine. Start engine. Release the parking brake.
3. Ensure motion controls are in the neutral position.
4. If either drive wheel rotates while the motion control levers are in the neutral position, neutral adjustment is necessary.
5. Engage parking brake. Stop engine.

SERVICE

Service Motion Controls

Adjusting Motion Controls Neutral Center

1. Park machine safely, block front casters, engage parking brake.
2. Raise the rear of the machine, use jack stands or blocking under the chassis for safety. This procedure requires working on and running machine while on blocks, so make sure the machine is securely blocked.
3. Ensure motion controls are in the neutral position.

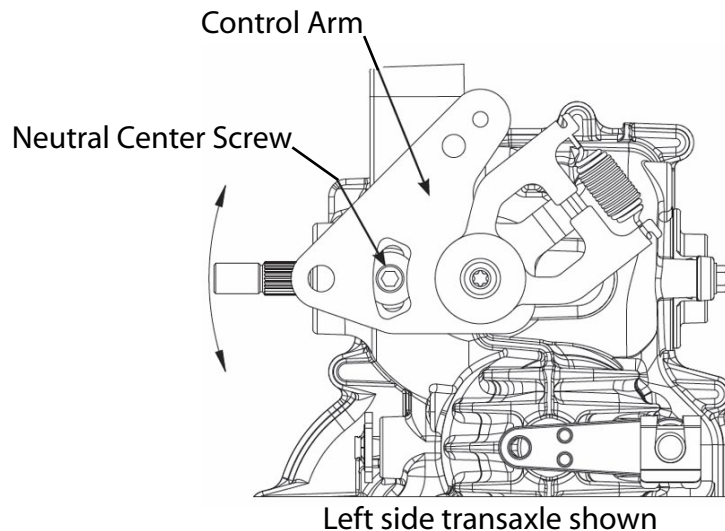

4. Using a 1/4" allen wrench, Slightly loosen cap screw to allow the rotation of neutral return plate.
5. If left drive wheel rotates forward, rotate the neutral plate clockwise.
If left drive wheel rotates backward, rotate the neutral plate counterclockwise.
If right drive wheel rotates forward, rotate the neutral plate counterclockwise.
If right drive wheel rotates backward, rotate the neutral plate clockwise.
6. Only very small adjustments are necessary to set neutral center.
7. Tighten cap screw.
8. Check motion controls to ensure they return to the neutral position.
9. Mount the machine. Start engine. Idle engine.
10. Release parking brake.
11. Cycle motion controls forward and back. Return them to neutral position.
12. Observe both drive wheels for rotation. Stop engine. Engage parking brake.
If either wheel rotates, repeat adjustment procedure until neutral is obtained.
13. If both wheels return to neutral and stop, lower machine.

SERVICE

Service Motion Controls

Adjusting Reverse Speed



CAUTION: Avoid injury!

Setting the reverse speed too fast may render machine uncontrollable. This procedure is meant to provide the owner a way to set a safe, controlled maximum reverse speed and adjust the reverse tracking.

1. Park machine safely.
2. Set parking brake.
3. Loosen the four nuts on the reverse handle bolts to allow it to move.
4. Set the reverse handle at the desired position, retighten the nuts.
5. Make sure to set both sides equally.
6. After making adjustments, check machine reverse operation for excessive speed and tracking. Re-adjust if necessary.

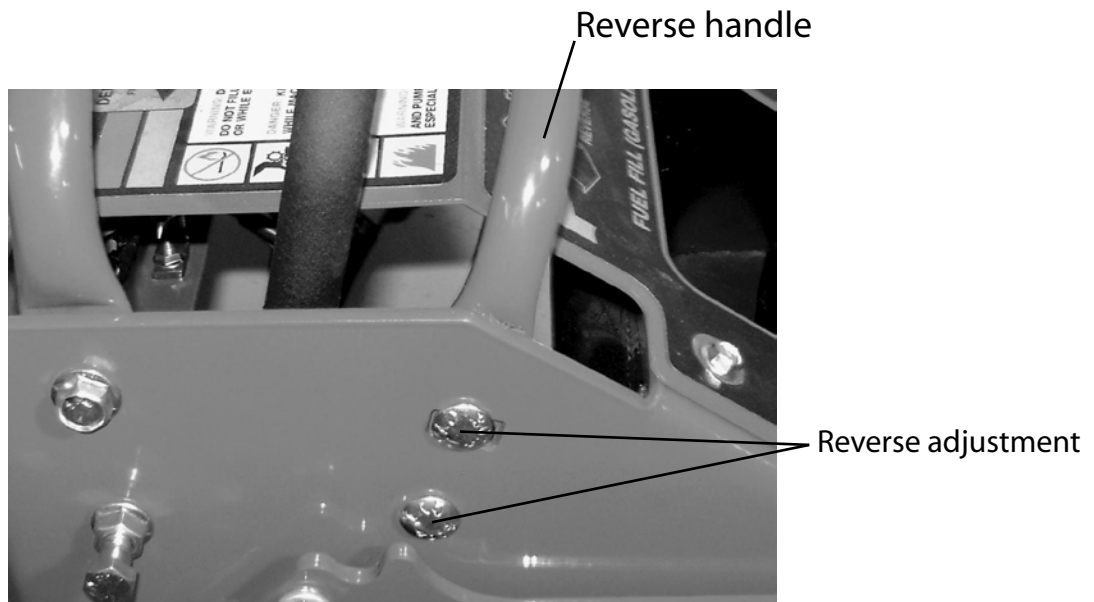

SERVICE

Service Tires

Removing and Installing Rear Drive Wheels

Removing:

1. Park machine safely.
2. Lift machine with a safe lifting device centered under operator foot pad, placing blocking under the side where tire is being removed.
3. Remove the 4 wheel lug nuts.
4. Remove wheel.

Installing:

1. Install wheel with valve stem facing out.
2. Install and tighten wheel lug nuts until seated in the rim.
3. Torque rear wheel lug nuts to 75 lb-ft. in a cross pattern until value is reached.
4. Lower machine.

Removing and Installing Front Caster Wheels

Removing:

1. Park machine safely.
2. Lift front of machine with a safe lifting device. Use jackstands.
3. Loosen and remove locknut and axle bolt from caster fork.
4. Slide wheel out of fork.

Installing:

1. Slide replacement wheel into caster fork.
2. Install axle bolt and locknut.
3. Tighten locknut until wheel develops slight rolling resistance.
4. Lower machine.

Checking Tire Pressure



CAUTION: Avoid injury! Explosive separation of tire and rim is possible when serviced incorrectly:

Do not attempt to mount a tire without the proper equipment and experience to perform the job.

Do not inflate the tires above the recommended pressure.

Do not weld or heat a tire and rim assembly. Heat can cause an increase in air pressure resulting in an explosion.

Welding can structurally weaken or deform the rim.

Do not stand in front or over the tire and rim when inflating.

Use a Clip-on chuck and extension hose long enough to allow you to stand to one side.

1. Check tires for damage.
2. Check tire pressure with an accurate gauge.
3. Add or release air as necessary.

Recommended pressures: Rear tire: **20 PSI - MAXIMUM 28 PSI**

Front tire: **40 PSI - MAXIMUM 46 PSI**

SERVICE

Service Electrical

Replacing Fuse



IMPORTANT: Avoid Damage! Help prevent machine electrical damage. Make sure replacement fuse is the correct rating.

1. Park machine safely.
2. Set parking brake.
3. Locate the fuse holder on the engine above the battery.

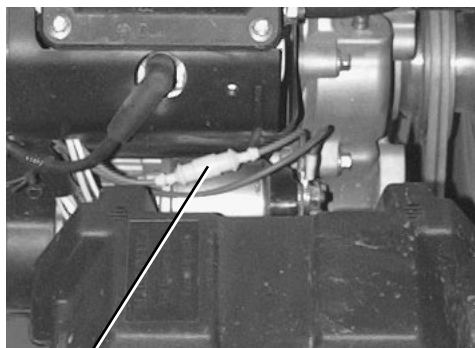

Fuse holder

4. Open the fuse holder by pulling it apart carefully.
5. Remove the fuse and replace with the same type and rating.
The fuse required is a AGC 30A glass fuse.
6. Carefully push the two halves of the fuse holder back together.
7. Turn on the lights to make sure that the fuse is properly installed.
8. Turn off lights.

SERVICE

Service Electrical

Removing and Installing Battery



CAUTION: Avoid injury! Battery electrolyte contains sulfuric acid. It is poisonous and can cause serious burns:

- Wear eye protection and gloves.
- Keep skin protected.
- If electrolyte is swallowed, get medical attention immediately.
- If electrolyte is splashed into eyes, flush immediately with water for 15-30 minutes and get medical attention.
- If electrolyte is splashed onto skin, flush immediately with water and get medical attention if necessary.



WARNING: The battery produces a flammable and explosive gas. The battery may explode:

- Do not smoke near battery.
- Wear eye protection and gloves.
- Do not allow direct metal contact across battery posts.
- Disconnect negative cable first when removing battery.
- Reconnect negative cable last when installing battery.

1. Park machine safely.
2. Remove battery box cover strap.
3. Remove box cover.
4. Disconnect the Negative (-) battery cable first.
5. Disconnect the Positive (+) battery cable.
6. Grasp battery with both hands and lift straight up, pulling battery out of the box.
7. Installing is reverse of above.
8. Connect the positive (+) cable first.
9. Connect the negative (-) cable last.
10. Replace battery box top and strap.

Cleaning Battery and Terminals

1. Park machine safely.
2. Disconnect and remove battery. See above procedure.
3. Clean battery with one gallon of water mixed with four tablespoons of baking soda. Caution: Do not get the soda solution into the cells.
4. Rinse the battery thoroughly with plain water and dry.
5. Clean terminals and battery cable ends with wire brush to remove corrosion. Replace the terminal bolts if corroded.
6. Apply battery terminal grease to the terminals and cable ends to prevent corrosion.
7. Install battery.

SERVICE

Service Electrical

Using Booster Battery or Jump Starting



CAUTION: Avoid injury! The battery produces a flammable and explosive gas.

The battery may explode :

- Do not smoke or have open flame near battery.
- Wear eye protection and gloves.
- Do not jump start or charge a frozen battery.

Warm battery to 60°F before starting or charging.

1. Park machine safely.
2. Remove battery box cover strap.
3. Remove box cover.
4. Connect the positive cable to the discharged battery first, and then to the good battery.
5. Connect the negative jumper cable to the discharged battery first, and then to the good battery.
6. Start engine of disabled machine.
7. Disconnect the jumper cables from the good battery and then the discharged battery.

TROUBLESHOOTING

Using the Troubleshooting Chart

If you are experiencing a problem that is not listed in this chart, see the engine manufacturer's owner's manual provided with your machine for troubleshooting or see your authorized service center.

When you have checked all the possible causes listed and you are still experiencing the problem, see your authorized service center.

Engine

Poor engine performance

Fuel:

- Dirt in fuel system or fuel is old. Replace fuel with fresh stabilized fuel. Obtain fuel from another supplier before suspecting machine problems. Suppliers blend fuels differently and changing suppliers will generally solve any performance problems.
- Fuel blended with alcohol or ether may contribute to performance problems by causing gum and varnish deposits, especially if fuel is stored for several weeks or more. Obtain fresh fuel.
- Replace fuel filter.

Engine will not start or is hard to start

- Park brake lever not in the engaged position.
- Check that motion control levers are in neutral.
- Stale, low fuel level or improper fuel.
- Plugged fuel filter.
- Plugged air intake filter.
- Spark plug wires loose or disconnected.
- Spark plugs not gapped correctly.
- Blown fuse.
- Electrical problem – dead battery.
- Choke applied incorrectly.

TROUBLESHOOTING

Troubleshooting Chart

Engine

Engine will not slow idle

- Carburetion problems. See your authorized service center.
- Bent or kinked throttle cable.
- Bent governor control.
- Incorrect governor idle control.

Engine runs rough or stalls

- Plugged fuel filter.
- Plugged air intake system.
- Fuel cap vent dirty.
- Stale or improper fuel/fuel level.
- Spark plugs not gapped correctly.
- Replace spark plugs.
- Choke applied incorrectly.

Engine knocks

- Engine oil level low.
- Fuel is bad.
Fill tank with fresh fuel.
- Idle speed too slow.
Increase engine rpms.

Engine overheats

- Clean cooling fins.
- Clean engine cooling air intake screen.
- Low oil level.
- Do not operate at slow idle.
Operate at faster idle.
- Plugged engine air intake filter.

Engine lacks power

- Reduce load.
- Plugged engine air intake filter.
- Plugged fuel filter.
- Improper type of fuel.
Drain tank and fill with correct fuel.
- Clean cooling fins to help prevent overheating.
- Replace spark plugs.

TROUBLESHOOTING

Troubleshooting Chart

Engine

Engine backfires through muffler

- Throttle lever should be at low idle for thirty seconds before turning off machine.

High fuel consumption

- Improper type of fuel.
- Plugged air intake system.
- Improper valve clearance.
See your authorized service center.
- Restricted air intake filter.

Other symptoms

- See engine manufacturer's owner's manual provided with your machine for additional information.

Electrical System

Starter will not work

- Blown fuse.
- Park brake not engaged or switch is faulty.
- Loose or corroded battery connections.
- Motion controls not in neutral or neutral safety switches faulty.
- Key switch, starter relay or starter faulty.
See your authorized service center.

Battery will not charge

- Loose or corroded connections.
- Defective battery.
- Defective rectifier.
- See your authorized service center.

Starter turns slowly

- Loose or corroded battery connections.
- Defective battery.
- Low battery - charge battery.
- Engine oil viscosity too heavy.

Hydraulics

Steering

- Improper tire inflation.
- Pump free-wheel valve(s) partially open.
- Hydrostatic transmission oil level low.
- Pump drive belt loose or broken.
- Hydraulic pump or wheel motor faulty.

TROUBLESHOOTING

Troubleshooting Chart

Hydraulics

Machine will not move with engine running

- Parking brake engaged.
- Transmission oil level low.
- Transmission oil cold.
Allow machine to warm up.
- Pump drive belt slipping or broken.
- Pump free-wheel valves open.
- Transmission problems.
See your authorized service center.

Machine creeps with engine running and motion control levers in a neutral position

- Needs motion control linkage neutral center adjustment.

Machine

Excessive machine vibration

- Engine speed too slow.
Increase engine rpms.
- Drive belt not tensioned correctly.
- Impeller out of balance.
Check impeller for damage, cracks, broken or bent fins. If damaged in any way, REPLACE IMPELLER.

Discharge deflectors not opening or closing

- Deflector switch broken or sticking, replace switch.
See your authorized service center.
- Deflector breaker bad, replace.
See your authorized service center.
- Deflector motor damaged.
See your authorized service center.

STORAGE

Storing Machine Safety



CAUTION: Avoid injury! Fuel vapors are explosive and flammable.
Engine exhaust fumes contain carbon monoxide
and can cause serious illness or death:

- Run the engine only long enough to move the machine to or from storage.
- Do not store vehicle with fuel in the tank inside a building where fumes may reach an open flame or spark.
- Allow the engine to cool before storing the machine in any enclosure.

Preparing Machine for Storage

1. Repair any worn or damaged parts. Replace parts if necessary.
Tighten loose hardware.
2. Remove debris from machine.
3. Wash the machine and apply wax to metal and plastic surfaces.
4. Run machine for five minutes to dry belts and pulleys.
5. Apply light coat of engine oil to pivot and wear points to prevent rust.
6. Check tire pressure.

Preparing Fuel and Engine For Storage

Fuel:

If you have been using "Stabilized Fuel," add stabilized fuel to tank until the tank is full. Turn off fuel shutoff.

NOTE: Filling the fuel tank reduces the amount of air in the fuel tank and helps reduce deterioration of fuel.

If you are not using "Stabilized Fuel":

1. Park machine safely in a well-ventilated area.
NOTE: Try to anticipate the last time the machine will be used for the season so very little fuel is left in the fuel tank.
2. Turn on engine and allow to run until it runs out of fuel.
3. Turn key to off position.
4. Mix fresh fuel and fuel stabilizer in separate container.
Follow stabilizer instructions for mixing.
5. Fill fuel tank with stabilized fuel.
6. Run engine for a few minutes to allow fuel mixture to circulate through carburetor on engine.
7. Turn off engine. Turn off the fuel shutoff.

STORAGE

Storing Machine Safety

Engine storage:

1. Change engine oil and filter while engine is warm.
2. Service air filter if necessary.
3. Clean debris from engine air intake screen.
4. Remove spark plugs. Put 1 oz of clean engine oil in cylinders.
Install spark plugs, but do not connect spark plug wires.
Crank the engine five or six times to allow oil to be distributed.
5. Clean the engine and engine compartment.
6. Remove battery.
7. Clean the battery and battery posts.
8. Close fuel shut-off valve.
9. Store the battery in a cool, dry place where it will not freeze.
NOTE: The stored battery should be recharged every 90 days.
10. Store the vehicle in a dry, protected place.
NOTE: Put a waterproof cover over on machine if stored outside.

Removing Machine From Storage

1. Check tire pressure.
2. Check engine oil level.
3. Check battery. Charge battery if necessary.
4. Install battery.
5. Check spark plug gap. Install and tighten plugs to specified torque.
6. Open fuel shut-off valve.
7. Run the engine 5 minutes at mid throttle with deflectors closed to allow oil to be distributed throughout engine.
8. Be sure to test all safety systems before operating.

SPECIFICATIONS

Engine

Kohler Command Pro 27hp

See engine manufacturer's owner's manual for engine specifications.

Drivetrain

Type.....Dual Hydrostatic

Transaxles.....Hydro-Gear ZT3100

Number of SpeedsInfinitely Variable

Electrical System

Charging System.....20 Amp

Ignition.....Flywheel magneto

StarterSolenoid Shift

Fuse.....30 Amp AGC glass

Fuel System

Fuel Type..... Regular Unleaded Gasoline

Fuel Tank Location Between uprights, filler gauge on dash

Fuel Capacity 8.0 gallons

Steering and Brakes

Steering Dual Hydraulic Control Levers

Park Brake Drum brakes

Tires

Rear 18 x 6.5 - 8

Front 11 x 4 - 5

Inflation Rear (Maximum) 20-28 psi

Inflation Front (Maximum) 40-46 psi

Battery

Voltage..... 12-volt

BCI Group Size U1

Capacities

Fuel Tank 8 gallons

Hydraulic Oil (With Filter)..... approx. 5 quarts.

Engine Oil (With Filter) 1.75 quarts.

Dimensions

Width 2' 11"

Height 4' 5"

Length 4' 9"

Weight 710 lbs.

INDEX

SAFETY	2-10
OPERATOR CONTROLS.....	11-14
TESTING SAFETY SYSTEMS	15-16
STARTING	17
FUELING	18
OPERATING	19-20
BLOWER	21-22
SERVICE INTERVALS	23
SERVICE ENGINE	24-29
SERVICE HYDRAULICS	30-32
SERVICE BELT	33
SERVICE BRAKES	35
SERVICE CONTROLS	36-38
SERVICE TIRES	39
SERVICE ELECTRICAL	40-42
TROUBLESHOOTING	43-46
STORAGE	47-48
SPECIFICATIONS.....	49